

fischer**technik**

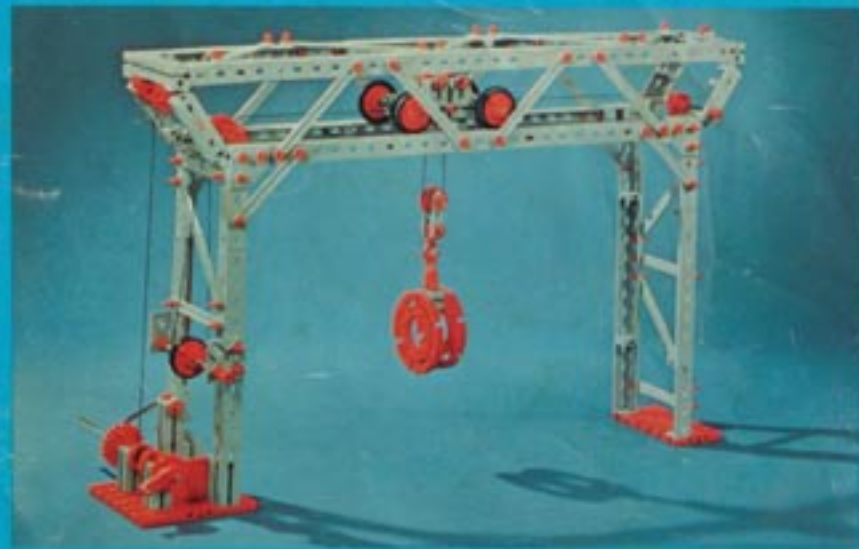

50 S/2

Aufbau-Statikkasten
extension pack
structural
boîte complémentaire
«superstructure»
cassetta statica
d'integrazione
aanbouw statikadoos



Art.-Nr. 6 39122 9

Aufbaustufen
der fischertechnik-
Statikkästen

extension packs for
fischertechnik structural
sets

possibilités d'extension
des boîtes «superstructure»
fischertechnik
fasi d'ampliamento delle
cassette fischertechnik
statica

uitbreidingsfasen van
de fischertechnik
statikadozen

▷ 100 S = 50 S + 50 S/1
200 S = 50 S + 50 S/1 + 50 S/2
300 S = 50 S + 50 S/1 + 50 S/2 + 50 S/3

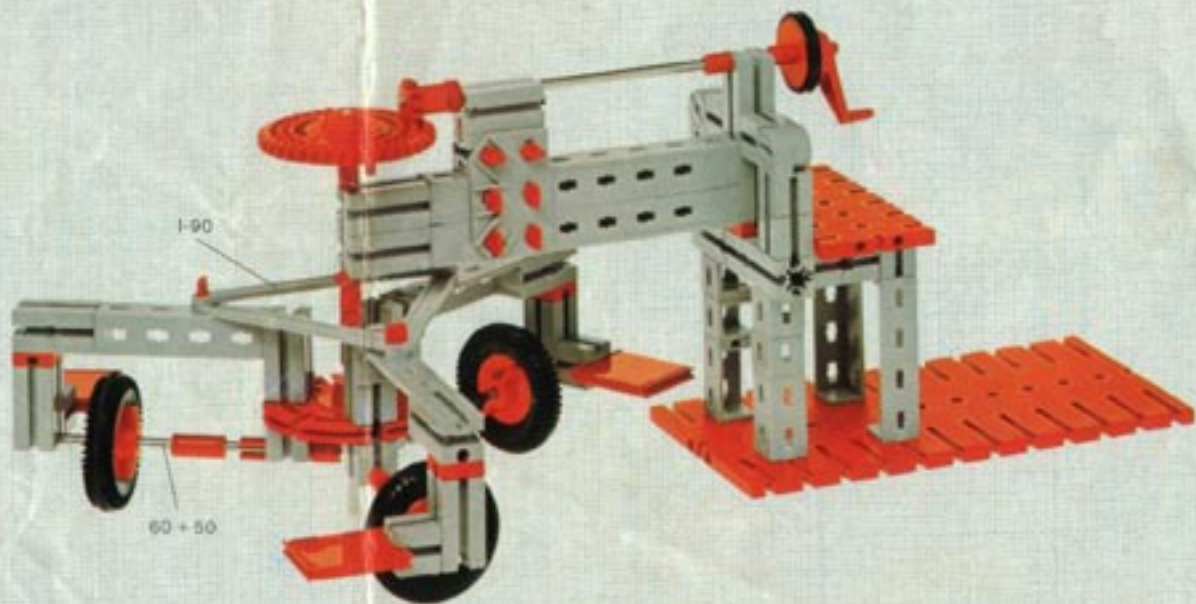

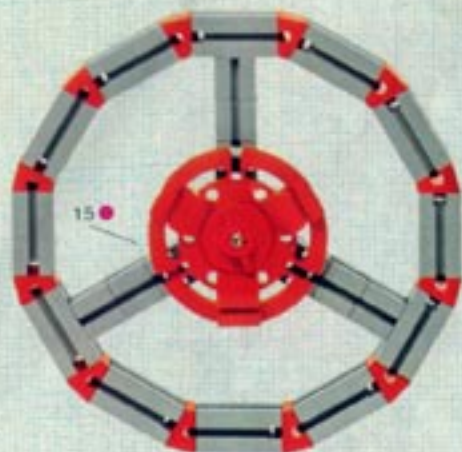
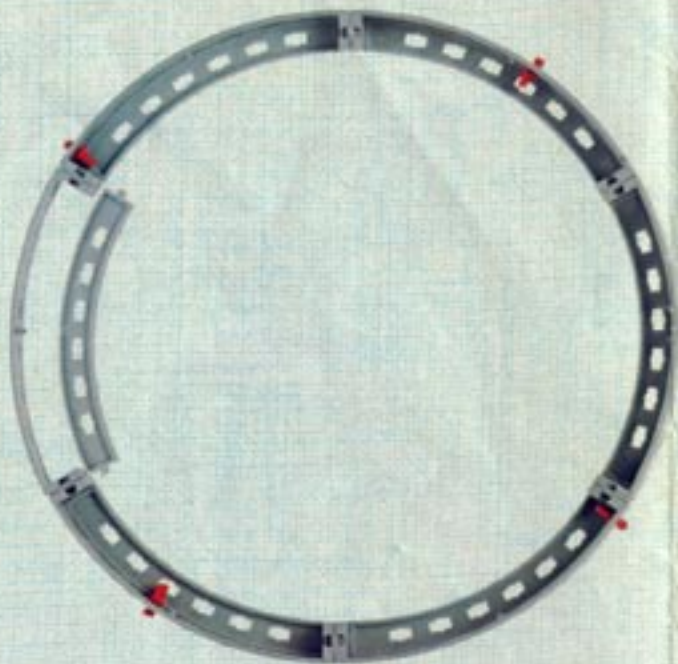

15

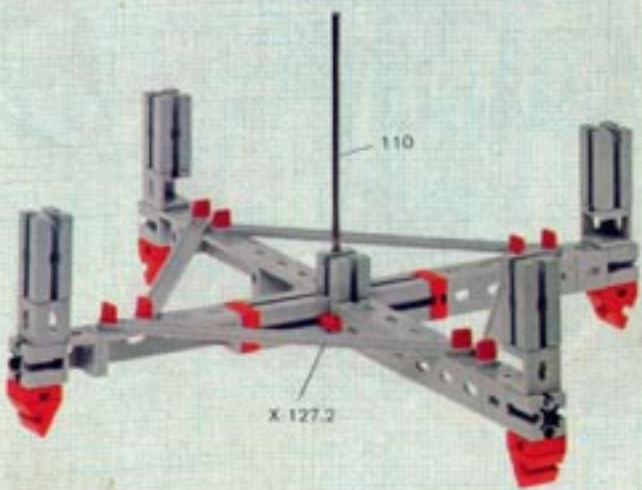

X-127.2



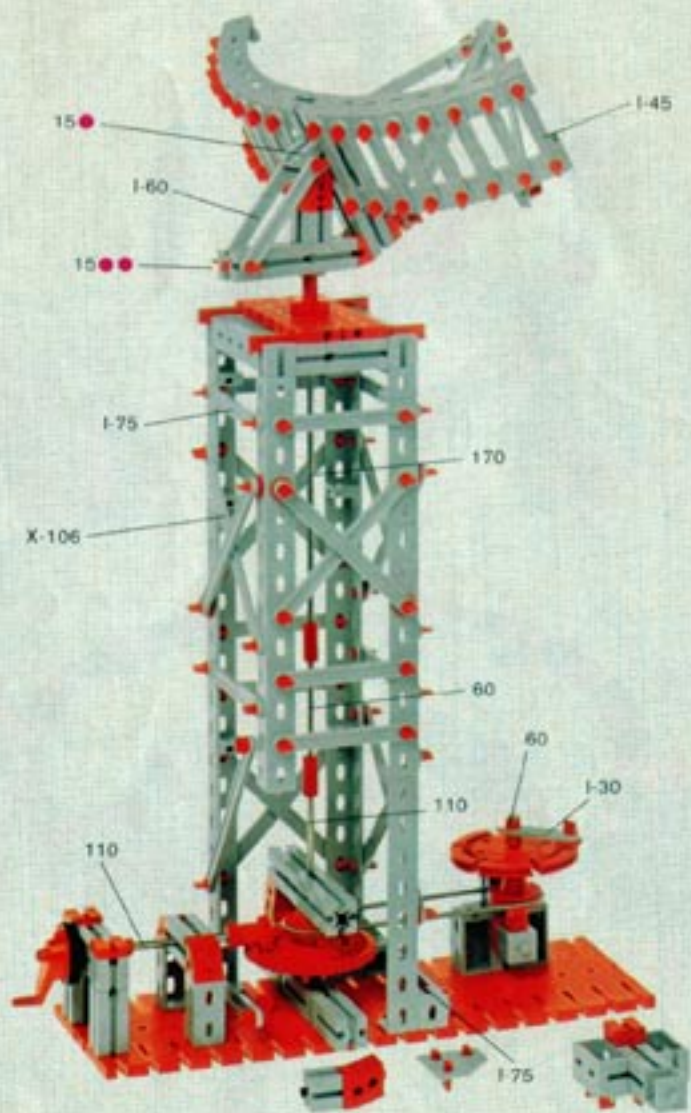

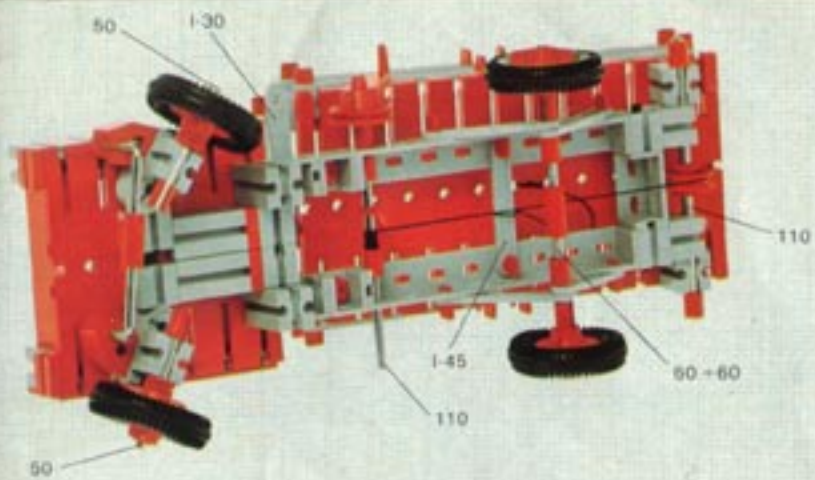
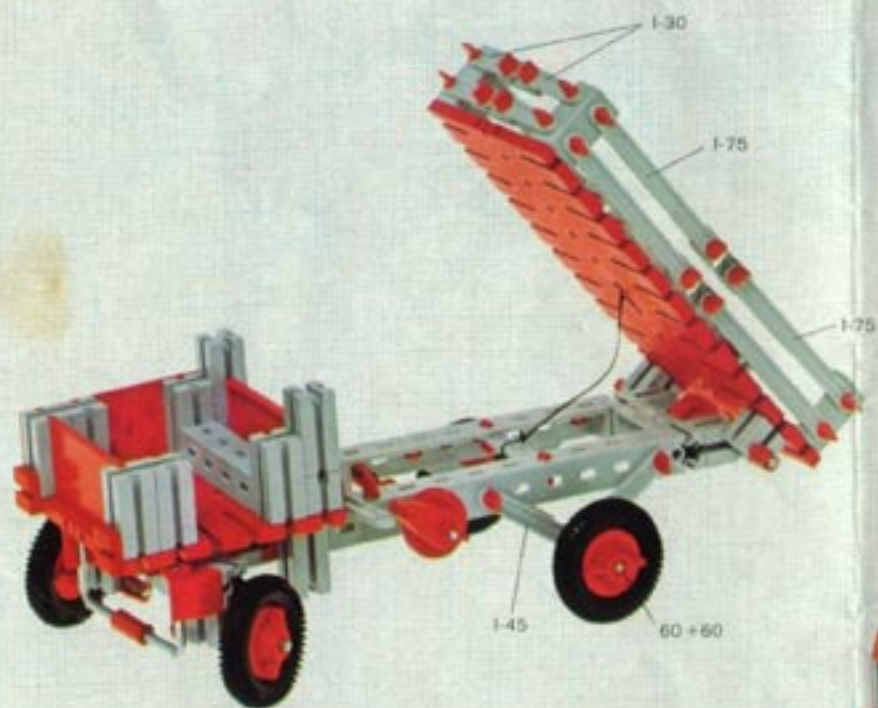

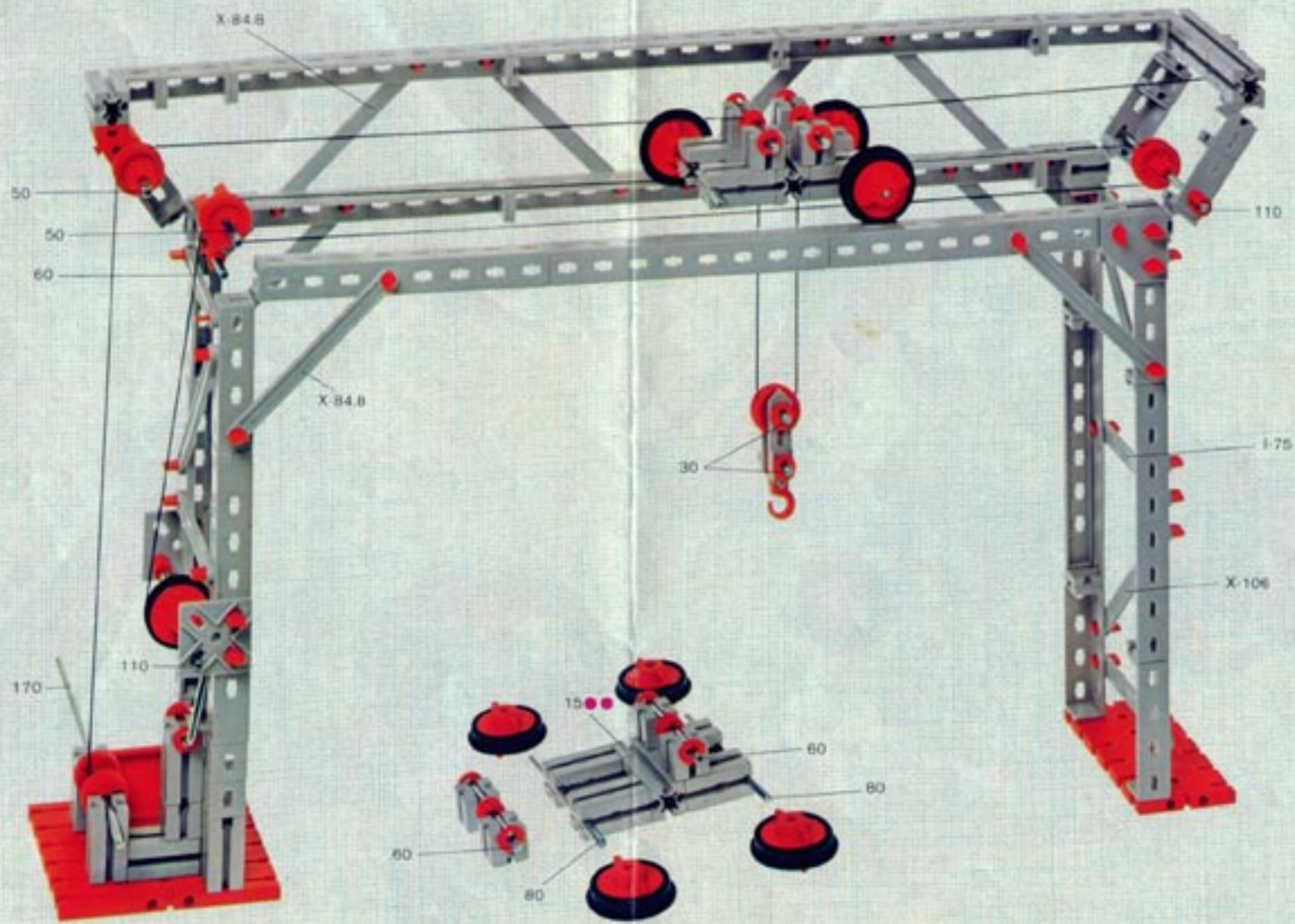

X-10E

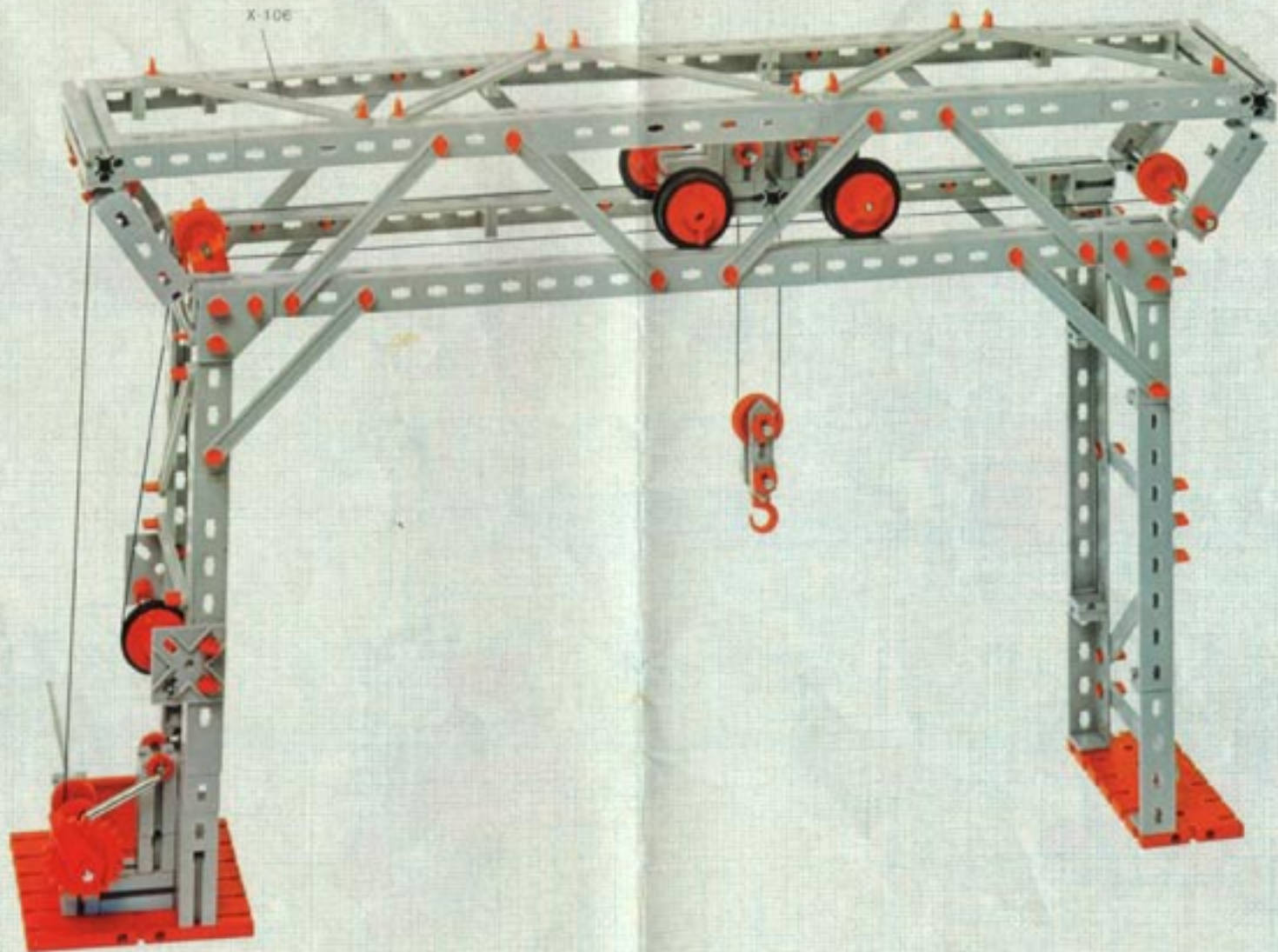

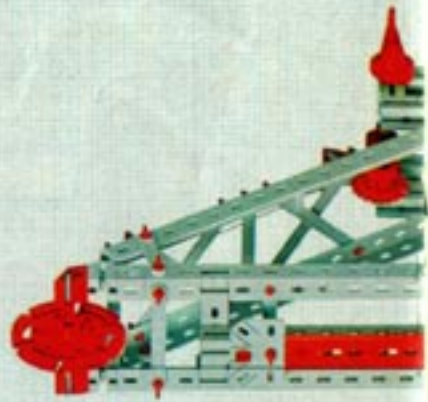
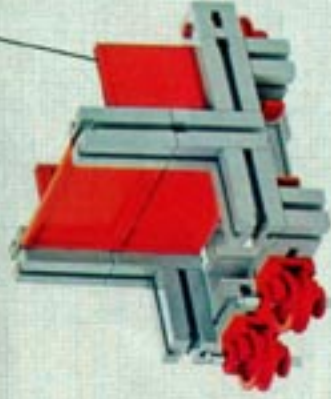
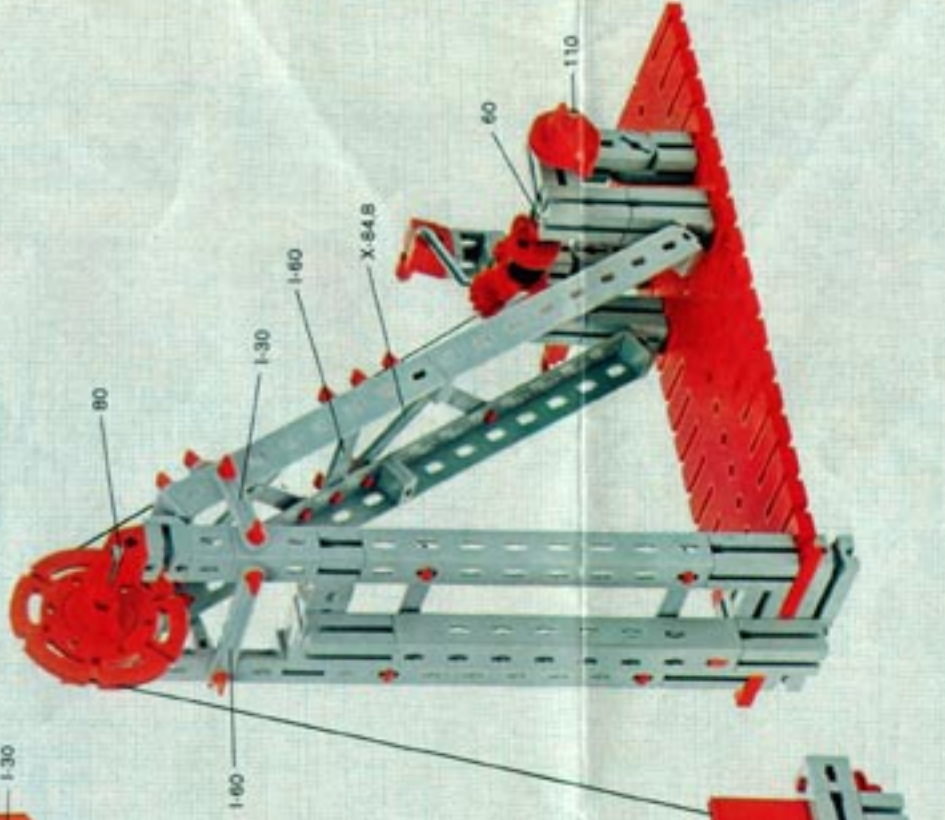
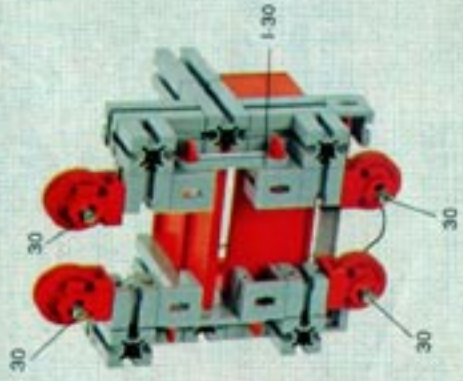

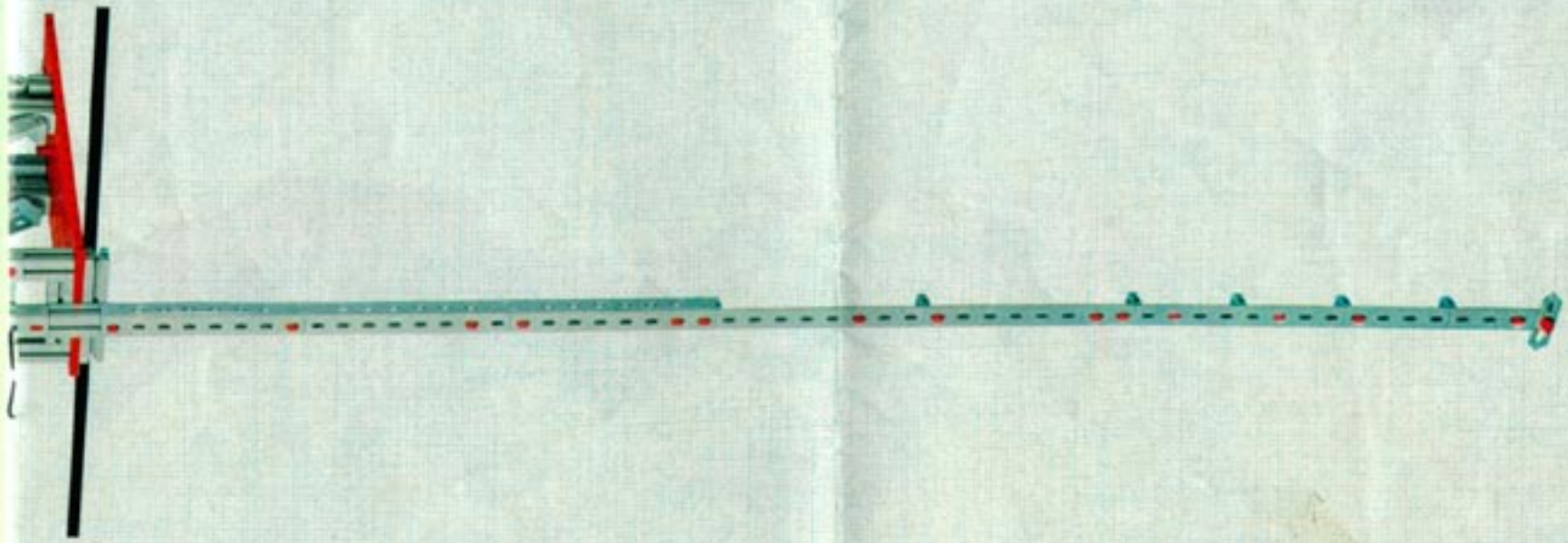
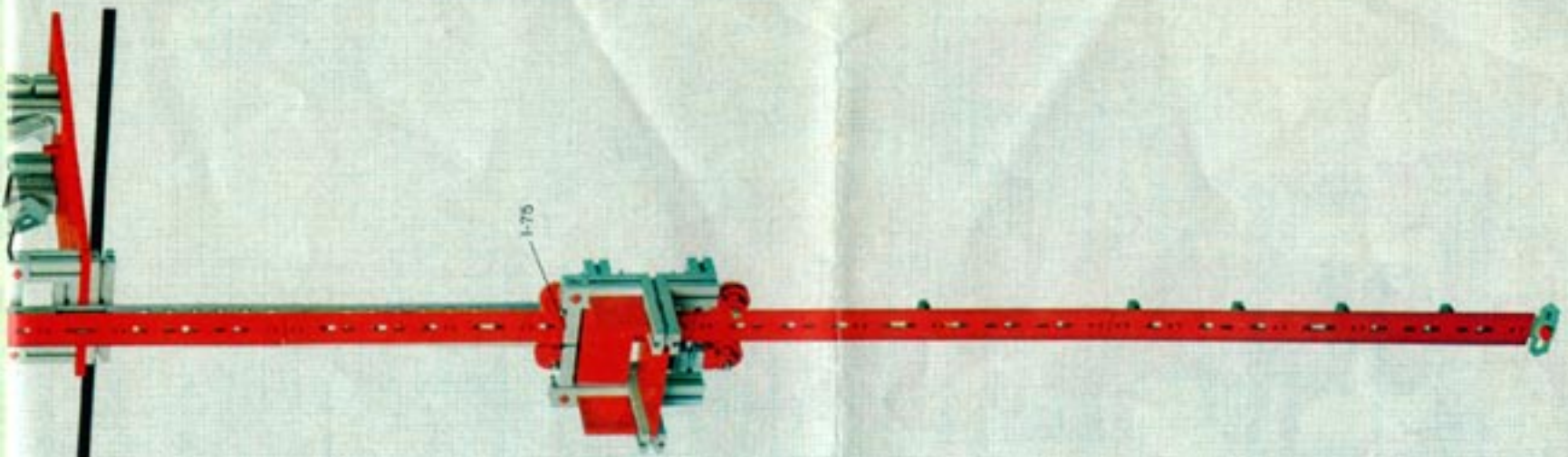

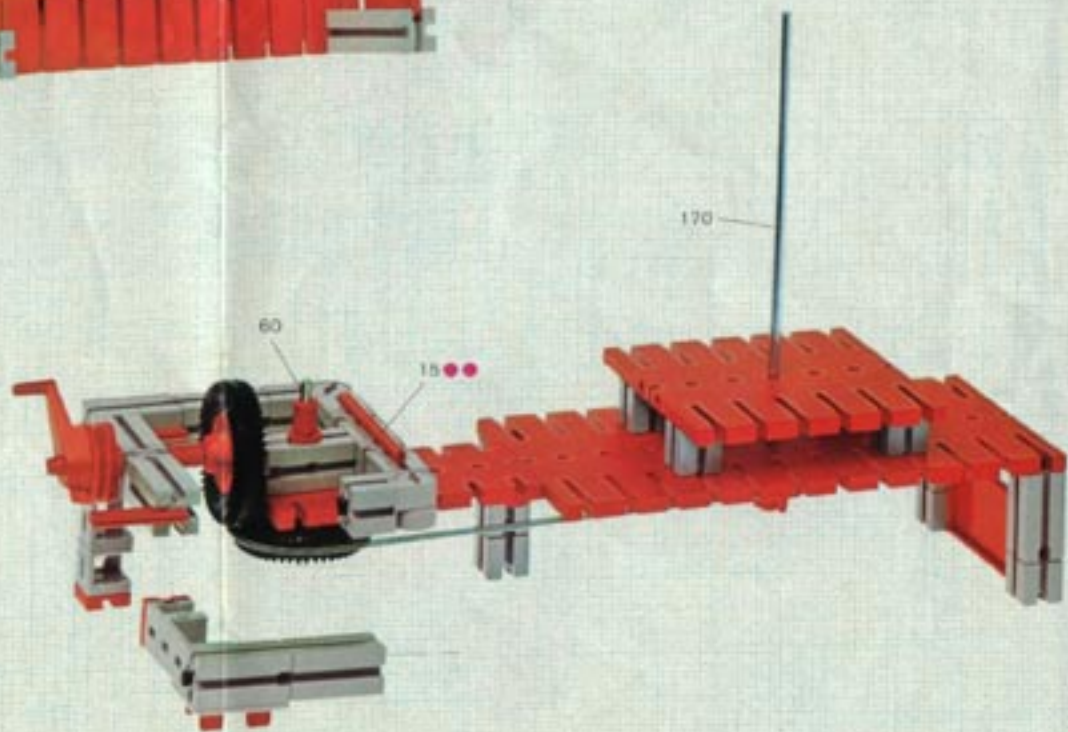
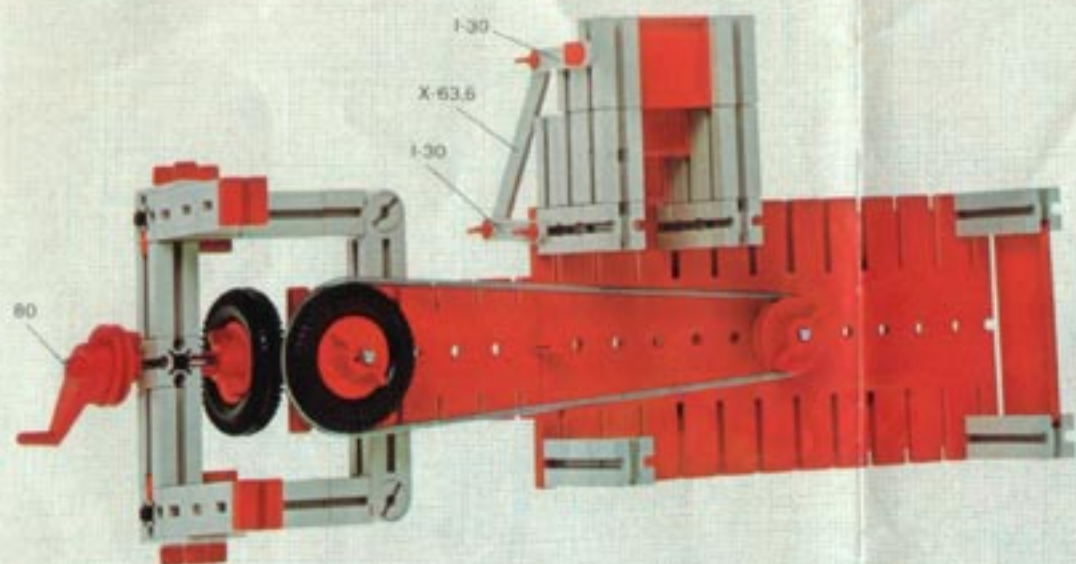

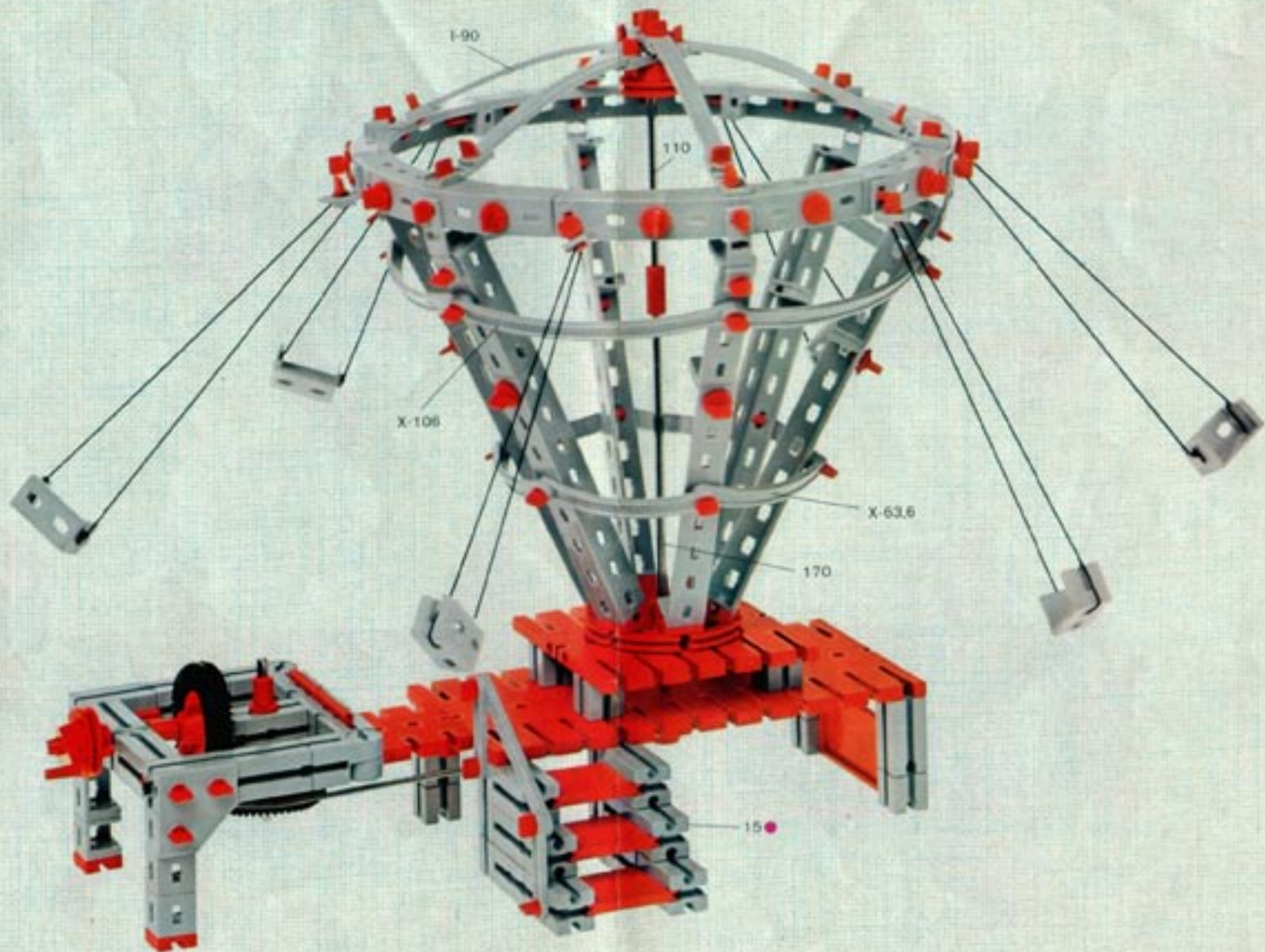

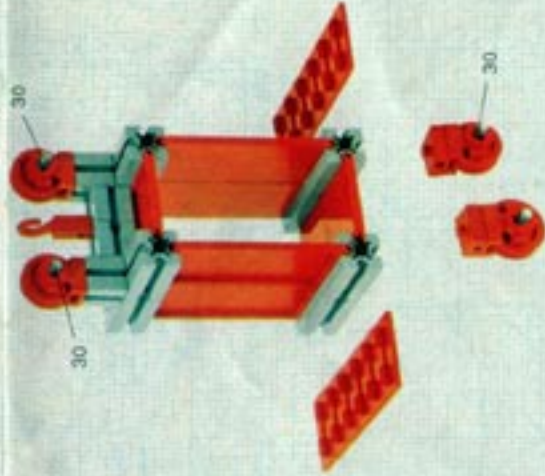
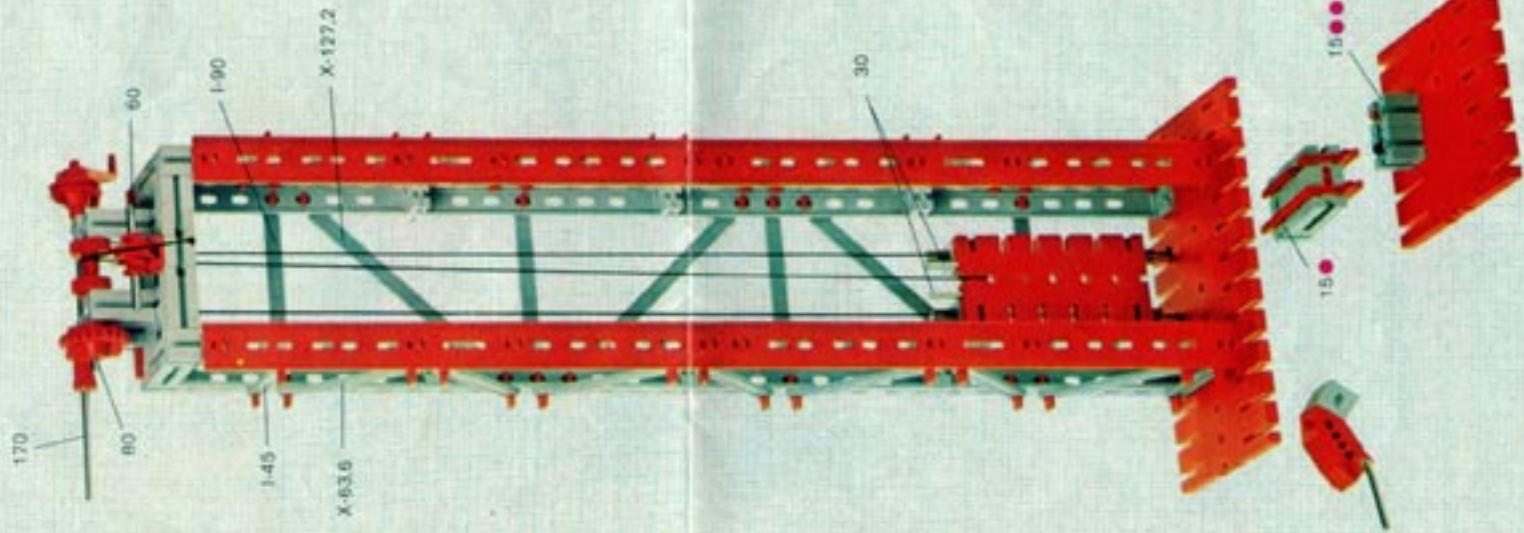
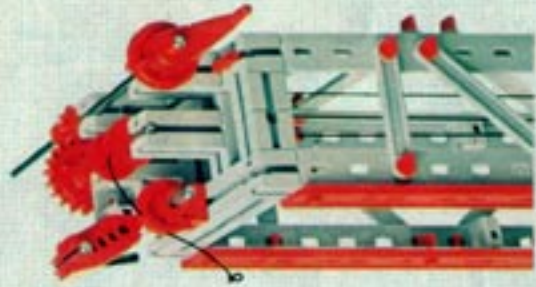

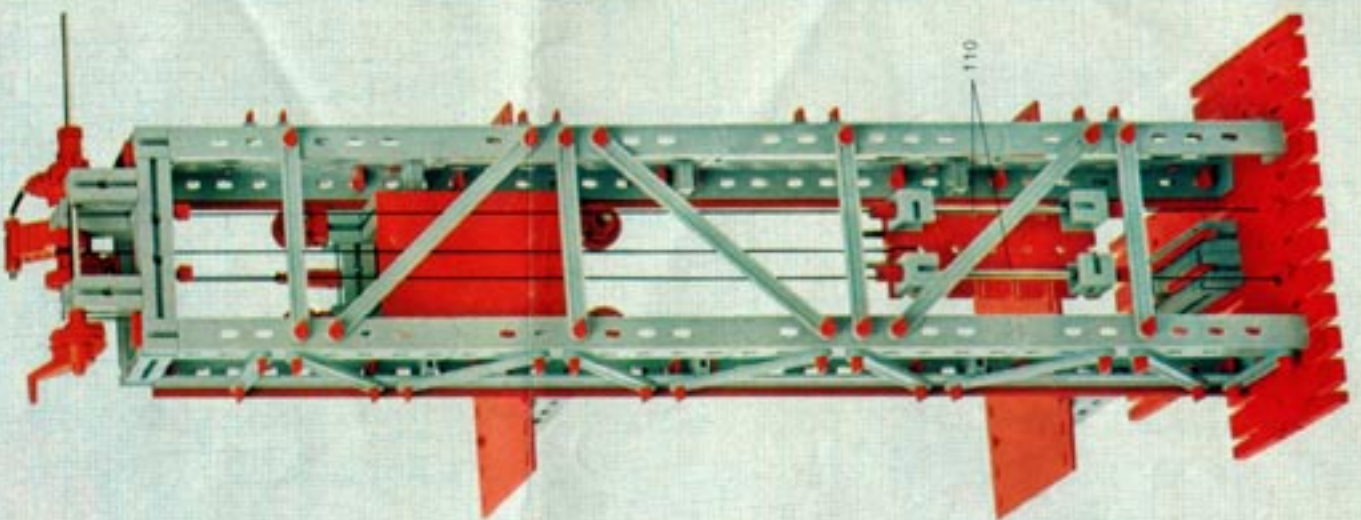
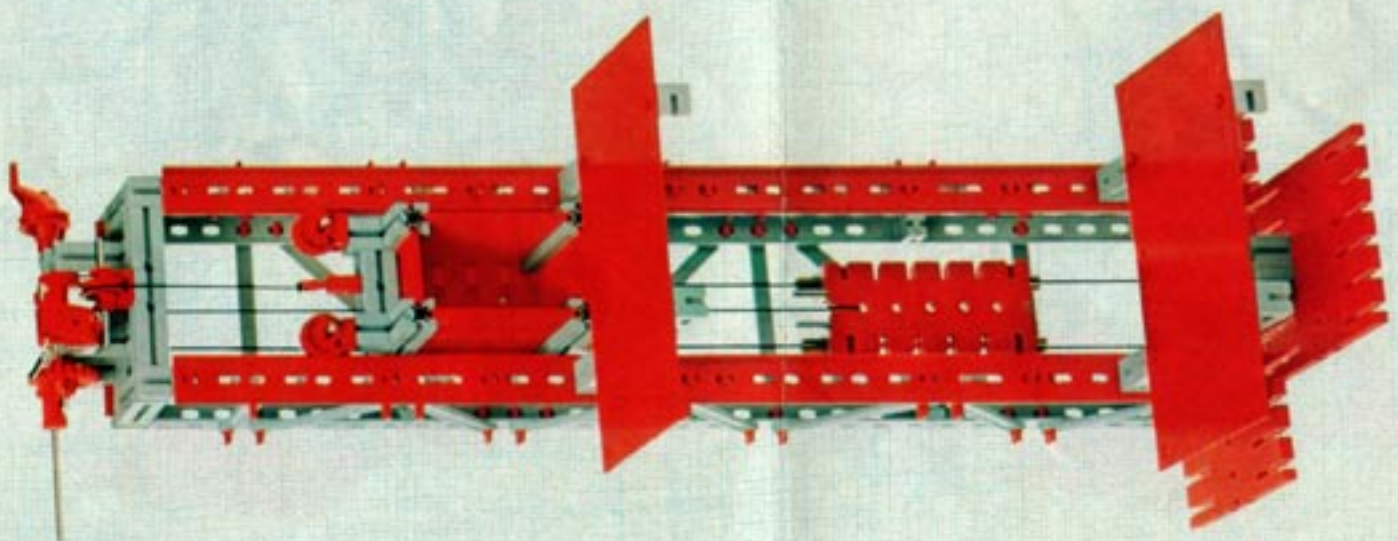

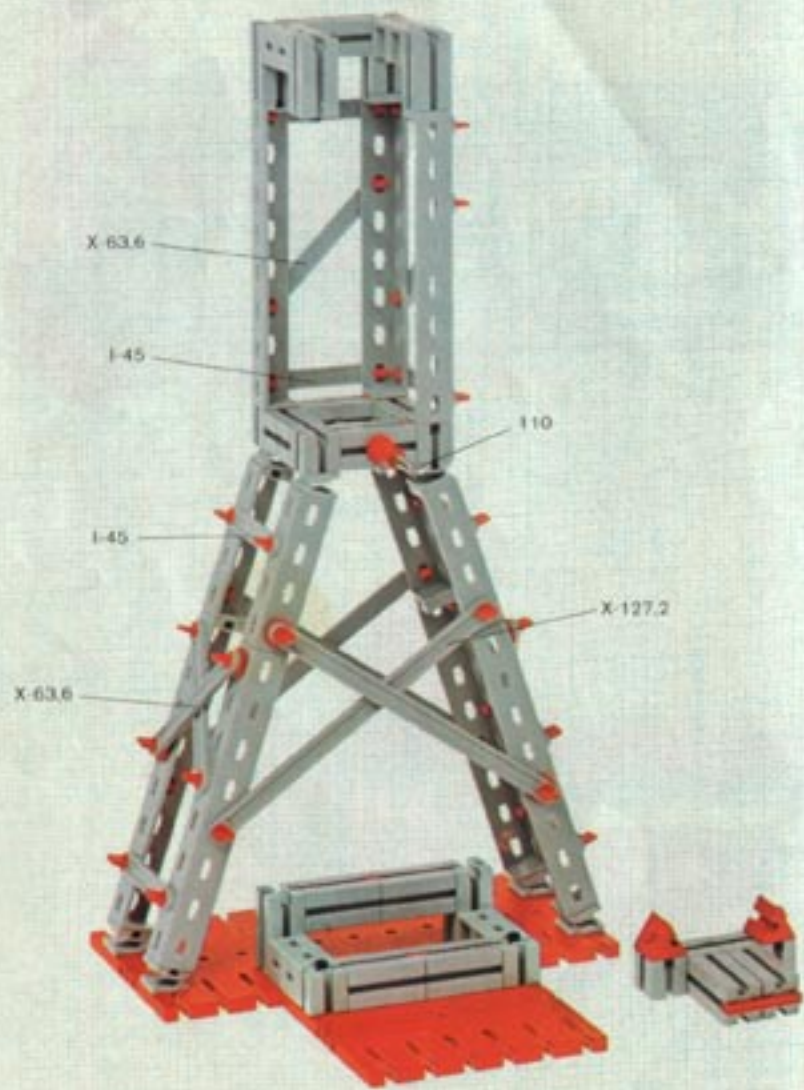

Stückliste · part list · nomenclature · elenco dei pezzi · onderdelen lijst					Stückliste · part list · nomenclature · elenco dei pezzi · onderdelen lijst				
Abbildung	Artikel-Nummer	SO S/2 Stück	Benennung	Zusatzkassen	Abbildung	Artikel-Nummer	SO S/2 Stück	Benennung	Zusatzkassen
	4 36303 1	4	Winkelträger 120 · angle girder 120 · corniere da 120 · trave angolare 120 · hoekdraagsteun 120	fl 051 4		4 36319 1	4	X-Strebe 127,2 · X-strut 127,2 · entretoise de 127,2 type X · diagonale X 127,2 · X-spant 127,2	fl 056 2
	4 36308 1	6	Bogenstück 60° · curved strut, small radius · plat cintré de 60° · pezzo curvo raggio piccolo · boogstuk, kleine radius	fl 057 3		4 36326 1	4	Lasche 15 · fish-plate 15 · éclisse de 15 · coprigiunto 15 · rechtverbindungsstück 15	fl 053 4
	4 36309 1	4	I-Strebe 30 · I-strut 30 · entretoise de 30 type I · diagonale I 30 · I-spant 30	fl 055 4		4 36327 1	2	Lasche 21,3 · fish-plate 21,3 · éclisse de 21,3 · coprigiunto 21,3 · rechtverbindungsstück 21,3	fl 053 4
	4 36310 1	8	I-Strebe 45 · I-strut 45 · entretoise de 45 type I · diagonale I 45 · I-spant 45	fl 055 8		4 36338 1	4	Winkellasche · angle fish-plate · éclisse coudée · coprigiunto angolato · hoekverbindingsstuk	fl 053 4
	4 36311 1	4	I-Strebe 60 · I-strut 60 · entretoise de 60 type I · diagonale I 60 · I-spant 60	fl 055 8		4 36330 1	2	Gelenklasche · hinge plate · charnière · coprigiunto a snodo · scharnierverbindungsstück	fl 053 4
	4 36312 1	8	I-Strebe 75 · I-strut 75 · entretoise de 75 type I · diagonale I 75 · I-spant 75	fl 055 4		4 36323 1	50	S-Riegel 4 · key-bolt 4 · rivet de 4 · chivistello 4 · grandel 4	fl 052 40
	4 36313 1	4	I-Strebe 90 · I-strut 90 · entretoise de 90 type I · diagonale I 90 · I-spant 90	fl 055 4		4 36324 1	10	S-Riegel 6 · key-bolt 6 · rivet de 6 · chivistello 6 · grandel 6	fl 052 16
	4 36314 1	8	I-Strebe 120 · I-strut 120 · entretoise de 120 type I · diagonale I 120 · I-spant 120	fl 055 2		4 36457 1	6	S-Riegel 8 · key-bolt 8 · rivet de 8 · chivistello 8 · grandel 8	fl 052 16
	4 36315 1	4	X-Strebe 42,4 · X-strut 42,4 · entretoise de 42,4 type X · diagonale X 42,4 · X-spant 42,4	fl 056 8		4 36334 1	12	Riegelscheibe · blocking washer · disque d'arrêt · rondella di fissaggio · grandelischijf	fl 052 16
	4 36316 1	8	X-Strebe 63,6 · X-strut 63,6 · entretoise de 63,6 type X · diagonale X 63,6 · X-spant 63,6	fl 056 8		3 35756 1	4	Spurkranz mit Gummiring · Flanged wheel with rubber ring · Jante à boudin avec bandage caoutchouc · Bordini con rivestimento di gomma · Flanswiel met rubberring	fl 058 4
	4 36317 1	4	X-Strebe 84,8 · X-strut 84,8 · entretoise de 84,8 type X · diagonale X 84,8 · X-spant 84,8	fl 056 8		4 35800 1	1	S-Griff · key-bolt tool · tourne-rivet · chiaveffa · S-greep	fl 052 1
	4 36318 1	8	X-Strebe 106 · X-strut 106 · entretoise de 106 type X · diagonale X 106 · X-spant 106	fl 056 4					

